

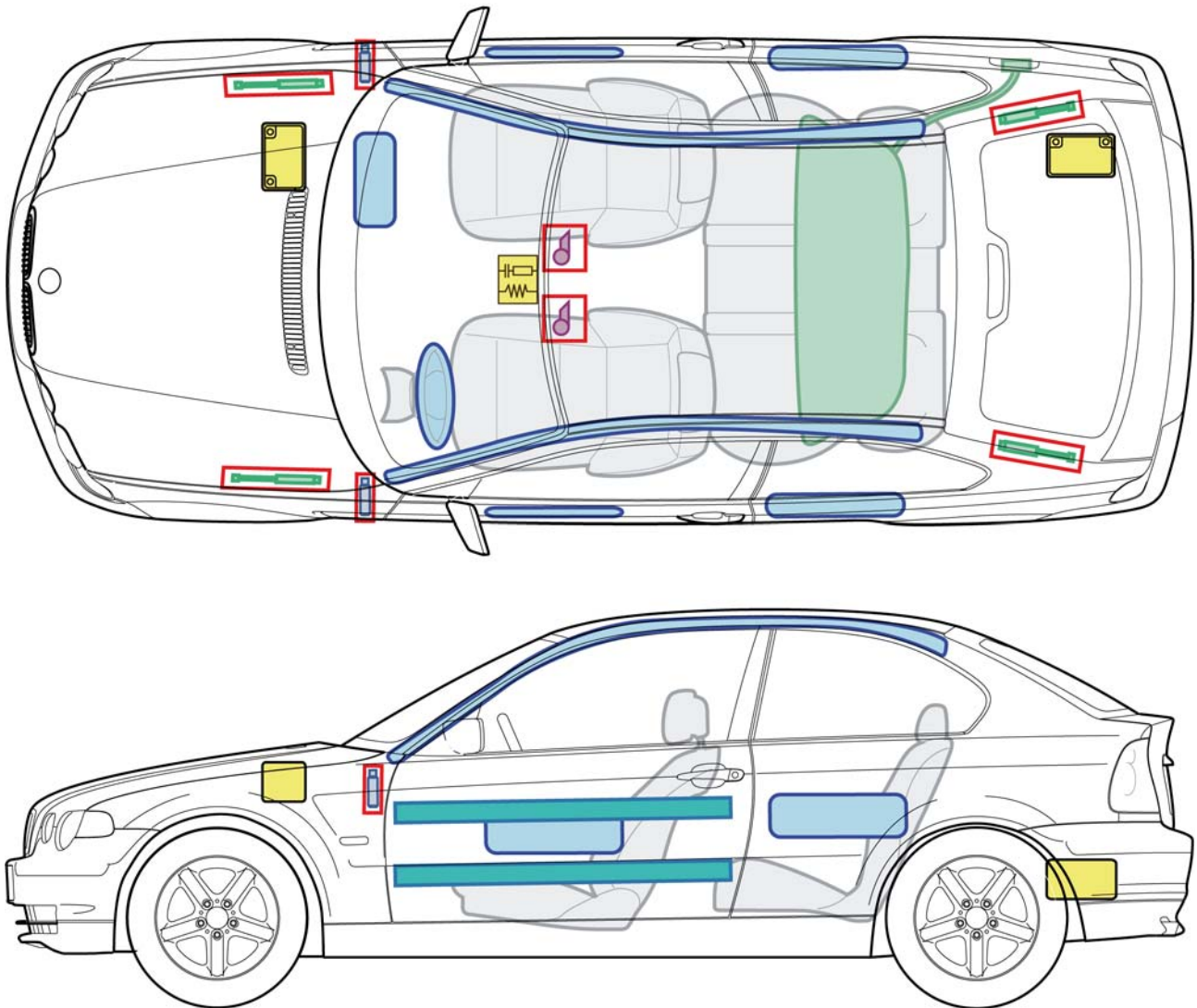









3 Series E46 Compact

(04/2001 - 12/2004)



Legend

	Airbag		Bodywork reinforcements		Airbag control unit
	Gas generator		Gas pressure damper		12-Volt battery
	Belt tensioner		Fuel tank		

This overview shows the maximum vehicle equipment.

Opening the car

This information applies only to trained rescue workers. An understanding of how safety systems work, along with a knowledge of the car's characteristics, are also required.

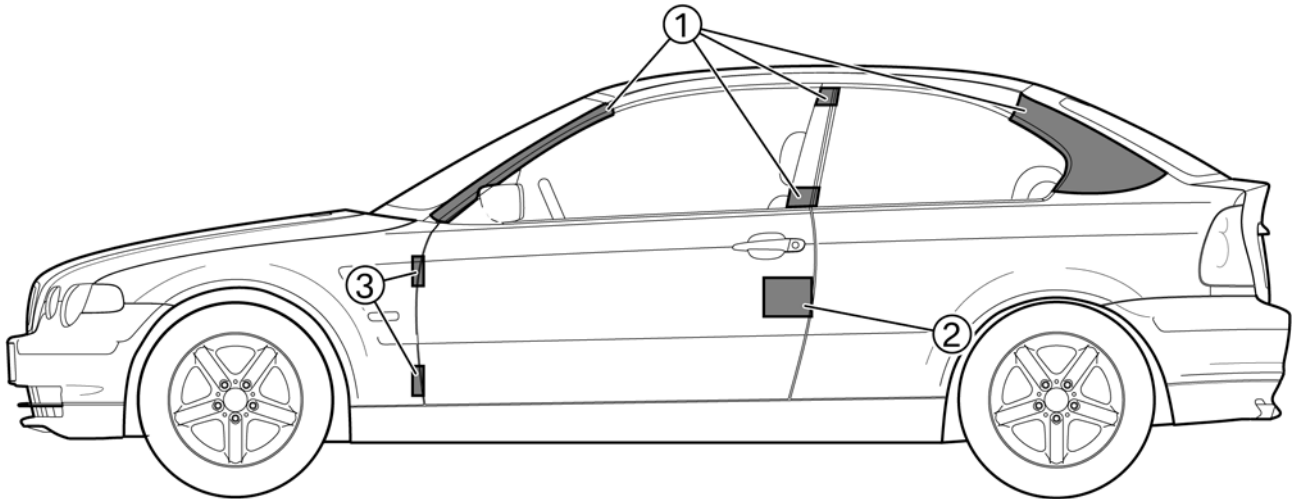

- 1 The areas mark points at which the roof can be disconnected.
Modern high-performance cutters are required for cutting open the bodywork; older hydraulic cutting devices may be insufficient.
The high-performance cutters must be used by trained personnel, expertly and properly.
- 2 Door locks
- 3 Door hinges

Important information

The information for relief units must be observed; see Emergency services guidelines, pages 4 - 33.