



# Rettungsdatenblätter

Informationen für Rettungskräfte





## Rechtlicher Hinweis

Diese Rettungsdatenblätter dienen der ausschließlichen Orientierung entsprechend ausgebildeter Rettungskräfte im Rahmen technischer Hilfeleistung an Chrysler, Dodge und Jeep-Fahrzeugen nach Verkehrsunfällen. Die Rettungsdatenblätter beziehen sich ausschließlich auf die Technologie von Fahrzeugen, die zum Verkauf in der Europäischen Union bestimmt sind. Die Technologie von Fahrzeugen anderer Märkte und hierin nicht aufgeführte Modellreihen kann abweichen; die Rettungsdatenblätter sind für solche Fahrzeuge aus Sicherheitsgründen nicht anwendbar. Die Datenblätter enthalten weiterhin keine grafischen Darstellungen zu Rechtslenkerfahrzeugen.

Änderungen der Technik, Ausstattung und Form der Fahrzeuge gegenüber den Angaben und Abbildungen in diesen Rettungsdatenblättern sowie Änderungen dieser Rettungsdatenblätter selbst bleiben vorbehalten.

Fahrzeugnutzer entnehmen detaillierte Informationen zur Funktionsweise ihres Fahrzeuges der fahrzeugeigenen Betriebsanleitung. Werkstätten und Händler erhalten technische Informationen über die ihnen bekannten Bezugsquellen.

Copyright 2010 Chrysler Deutschland GmbH  
Berlin, Germany

Die Erstellung der Rettungsdatenblätter und ihre Bereitstellung erfolgte mit freundlicher Unterstützung



der Firma Moditech Rescue Solutions B.V.

## ALLE RECHTE VORBEHALTEN

Die Vervielfältigung jeglicher Art, Übersetzung oder Verleihung, Vermietung oder Verkauf dieses Dokuments, im Ganzen oder zum Teil, ist nur mit vorheriger schriftlicher Genehmigung der Chrysler Deutschland GmbH erlaubt. Alle in diesem Dokument enthaltenen Informationen, Abbildungen und Spezifikationen stützen sich auf die zuletzt veröffentlichten Informationen, die zum Zeitpunkt der Veröffentlichung dieses Dokuments zur Verfügung standen. Die Chrysler Deutschland GmbH behält sich vor, Änderungen zu jeder Zeit und ohne vorherige Ankündigung vorzunehmen.



## Inhaltsverzeichnis

### Chrysler

---

300C	LX	Limousine	2005-
300C	LX	Kombi	2005-
Grand Voyager	RT		2007-
Sebring	JS	Limousine	2007-
Sebring	JS	Cabriolet	2007-

### Jeep

---

Cherokee	KK		2008-
Grand Cherokee	WH		2005-
Patriot	PK		2008-
Patriot Eco+	PK		2008-
Wrangler	JK	3-Türer	2006-
Wrangler	JK	5-Türer	2006-

### Dodge







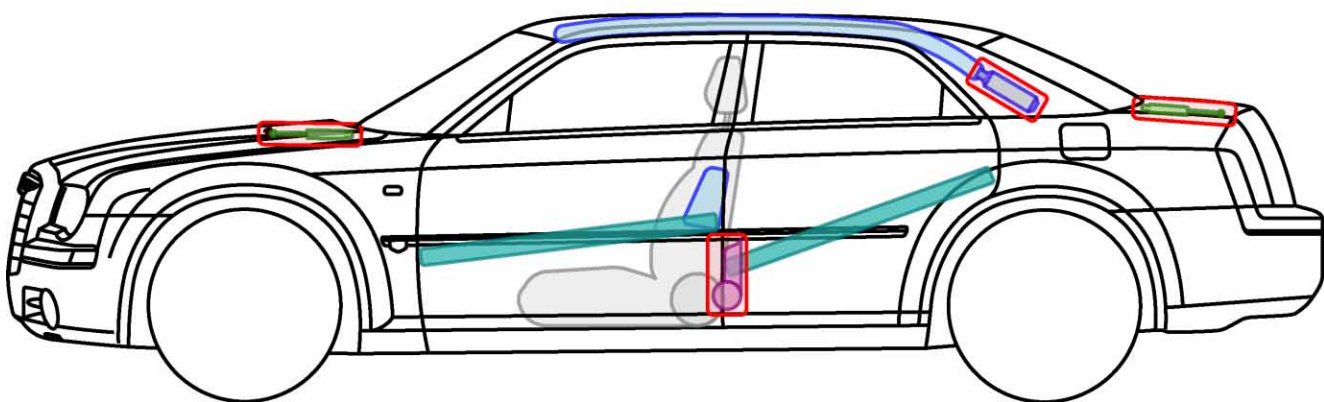
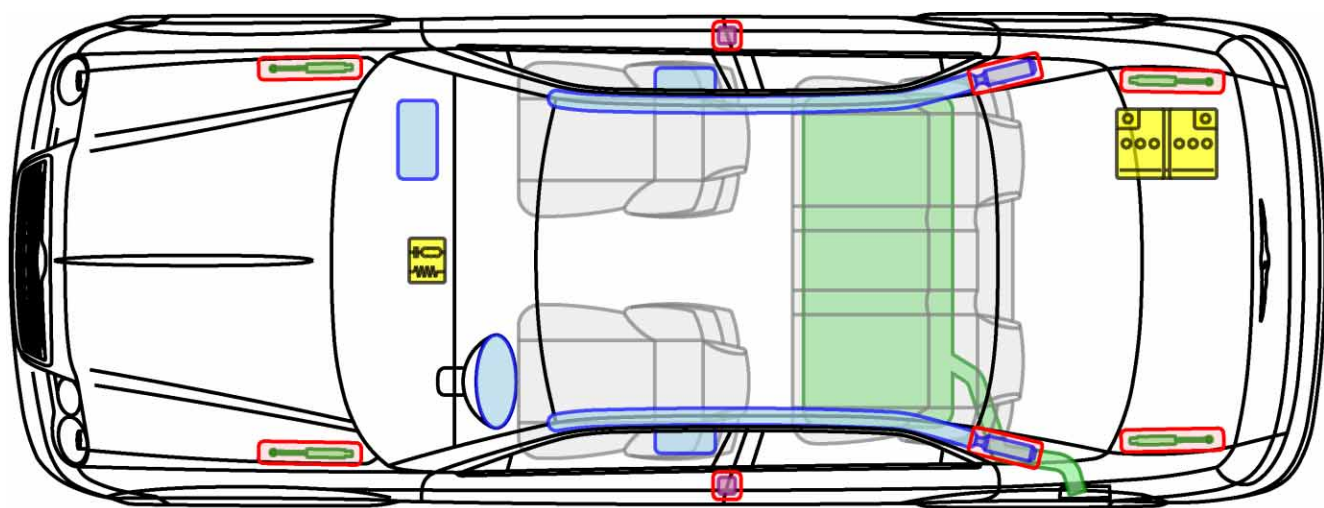

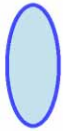

---

Journey	JC		2009-
Journey Eco+	JC		2009-
Caliber	PK		2006-
Nitro	KJ		2007-

**CHRYSLER 300C**  
Typ: LX, 2005-

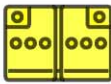

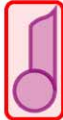
**Legende**







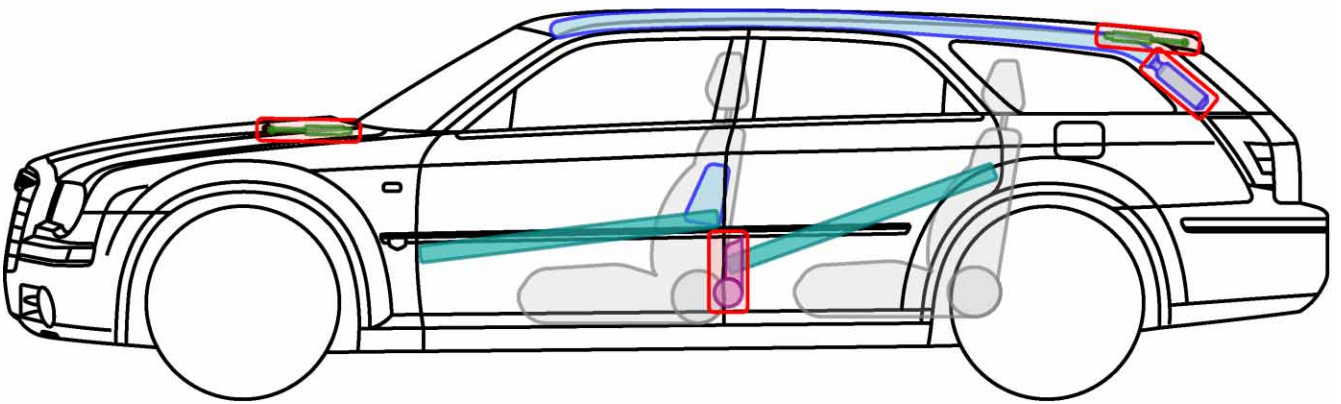
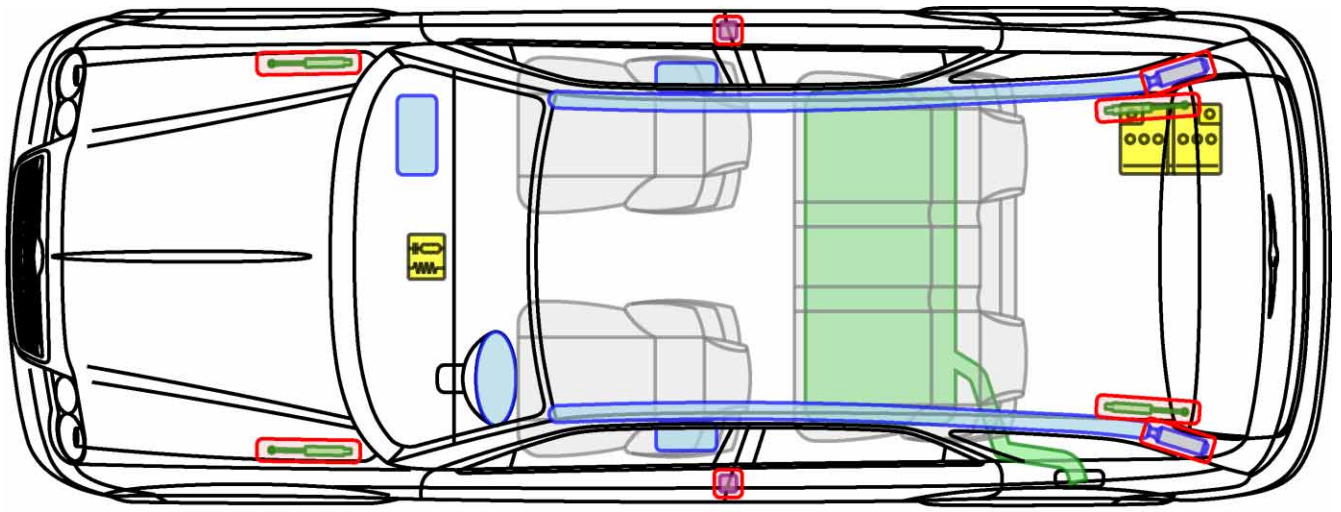

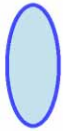

	Airbag		Karosserie- verstärkung		Steuergerät		Gastank
	Gas- generator		Überroll- schutz		Batterie		Sicherheits- ventil
	Gurt- straffer		Gasdruck- dämpfer		Kraftstoff- tank		

**Chrysler**

**CHRYSLER 300C**  
Typ: LX, 2005-

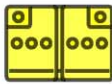

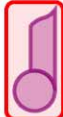





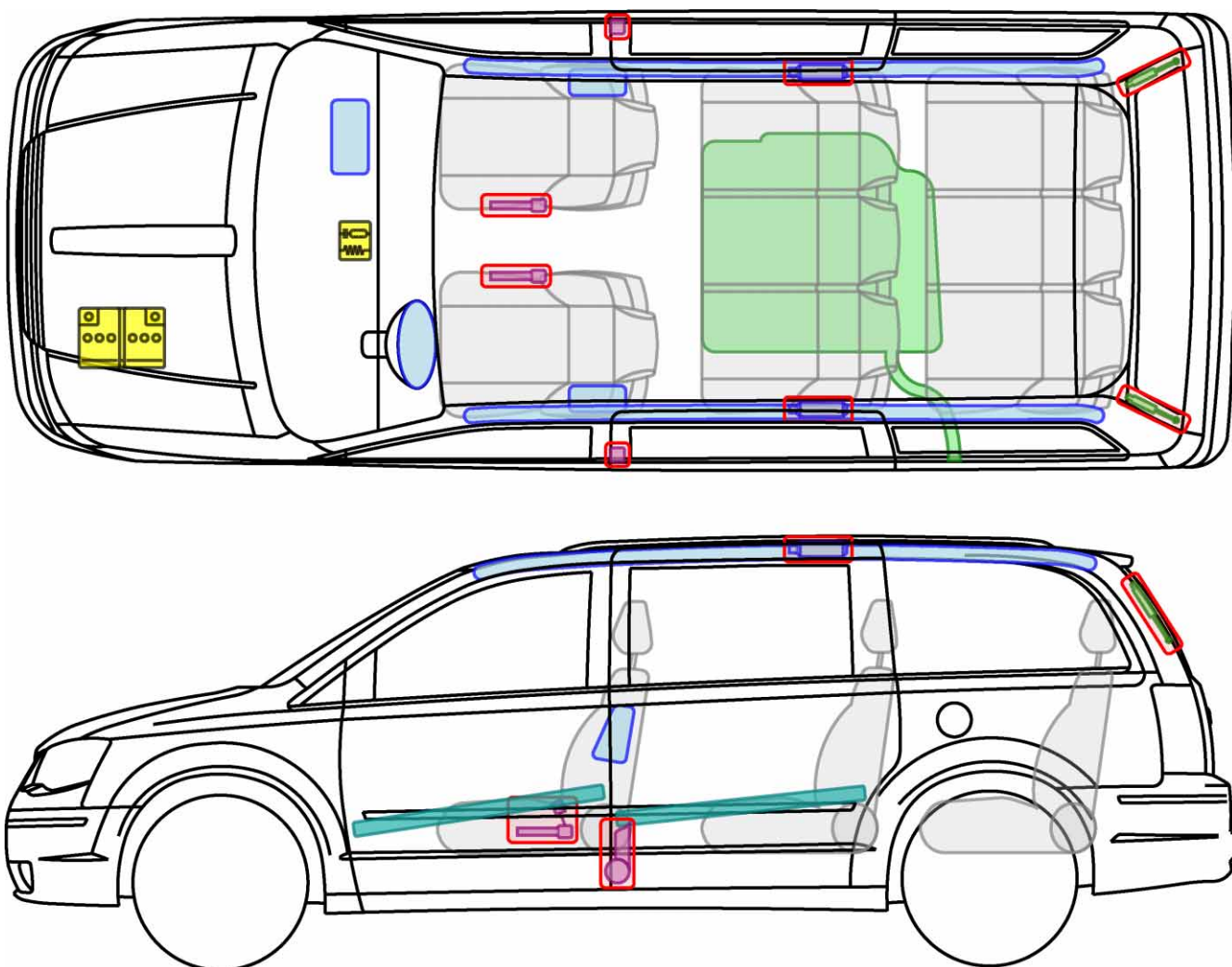

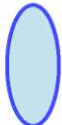

**Legende**

	Airbag		Karosserie- verstärkung		Steuergerät		Gastank
	Gas- generator		Überroll- schutz		Batterie		Sicherheits- ventil
	Gurt- straffer		Gasdruck- dämpfer		Kraftstoff- tank		

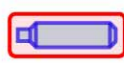
**Chrysler**

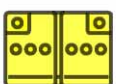

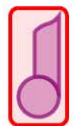
**Legende**

	Airbag		Karosserie- verstärkung		Steuergerät		Gastank
	Gas- generator		Überroll- schutz		Batterie		Sicherheits- ventil
	Gurt- straffer		Gasdruck- dämpfer		Kraftstoff- tank		

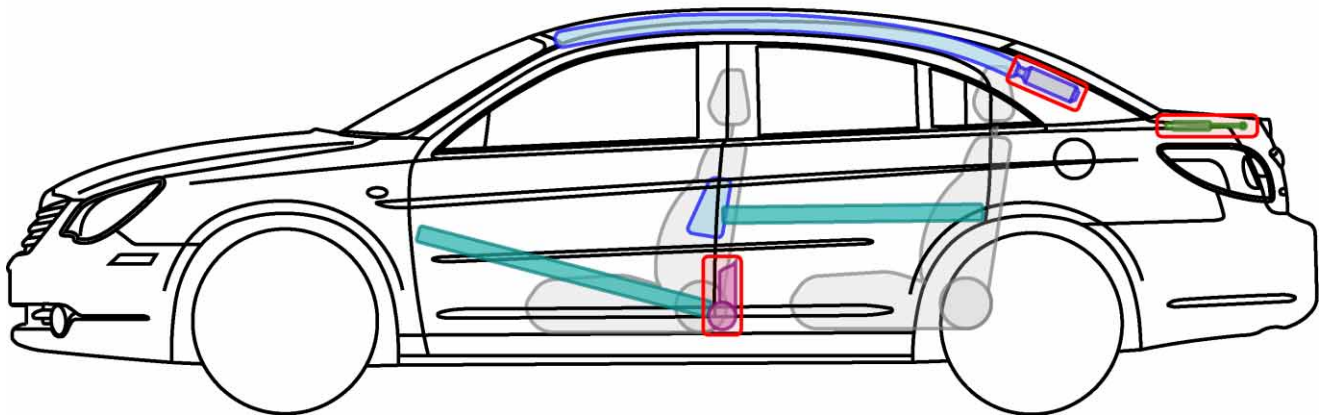
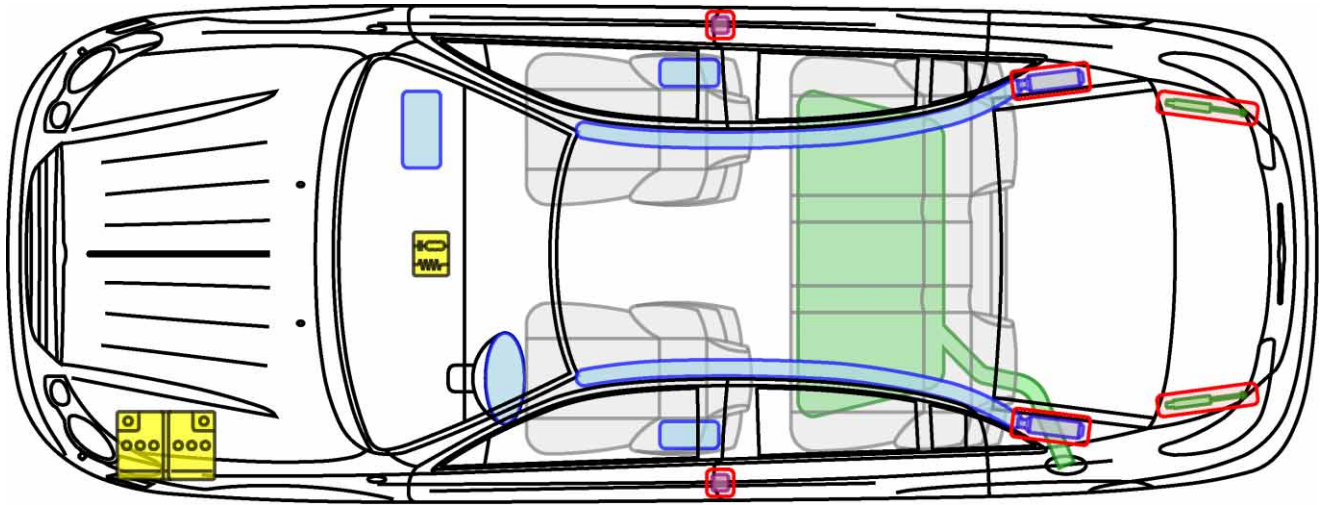





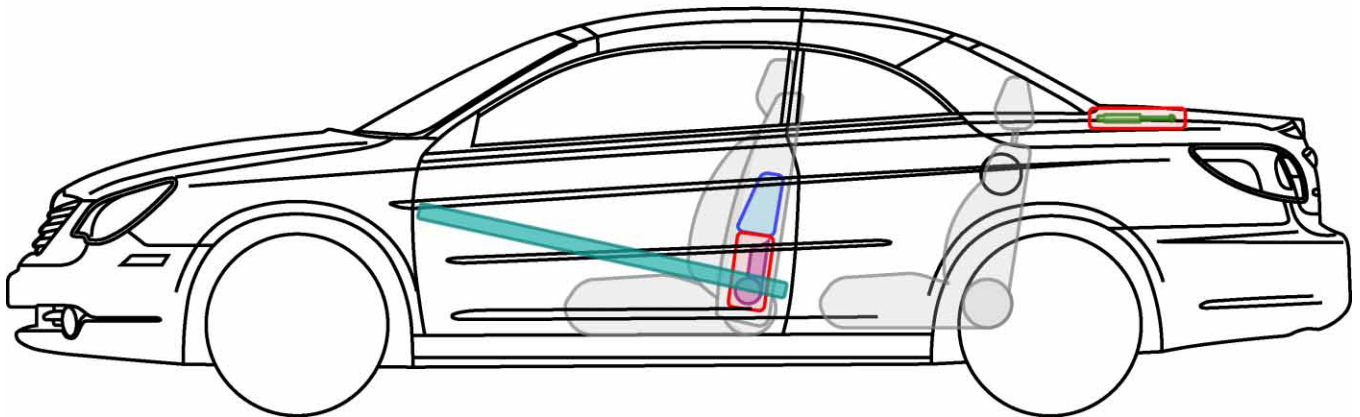
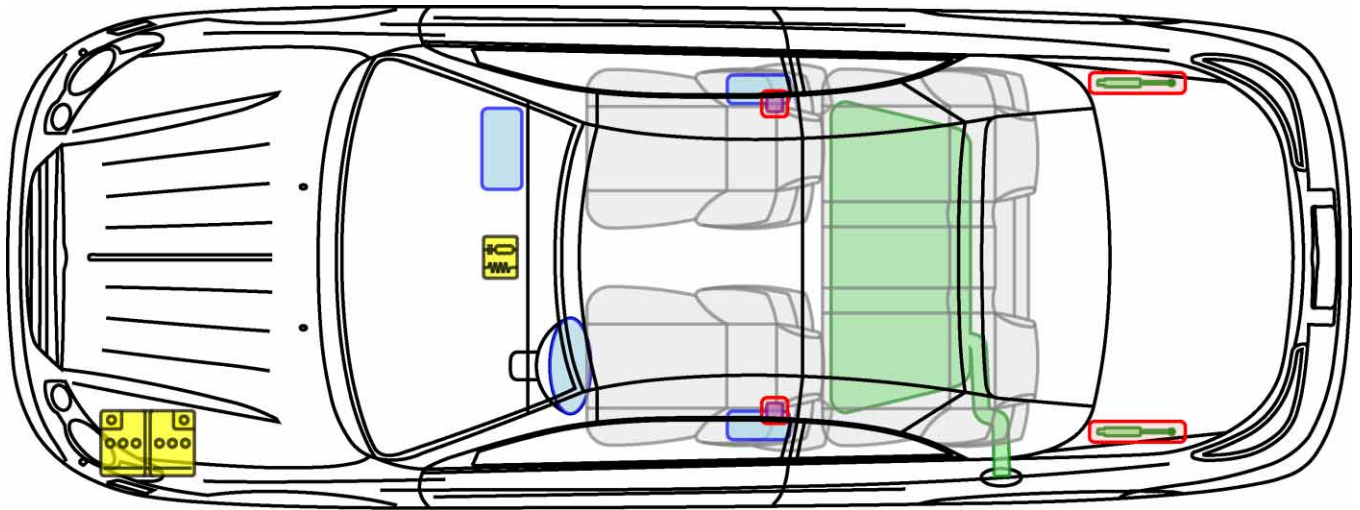



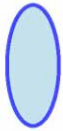

**Legende**

	Airbag		Karosserie- verstärkung		Steuergerät		Gastank
	Gas- generator		Überroll- schutz		Batterie		Sicherheits- ventil
	Gurt- straffer		Gasdruck- dämpfer		Kraftstoff- tank		

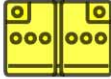



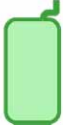



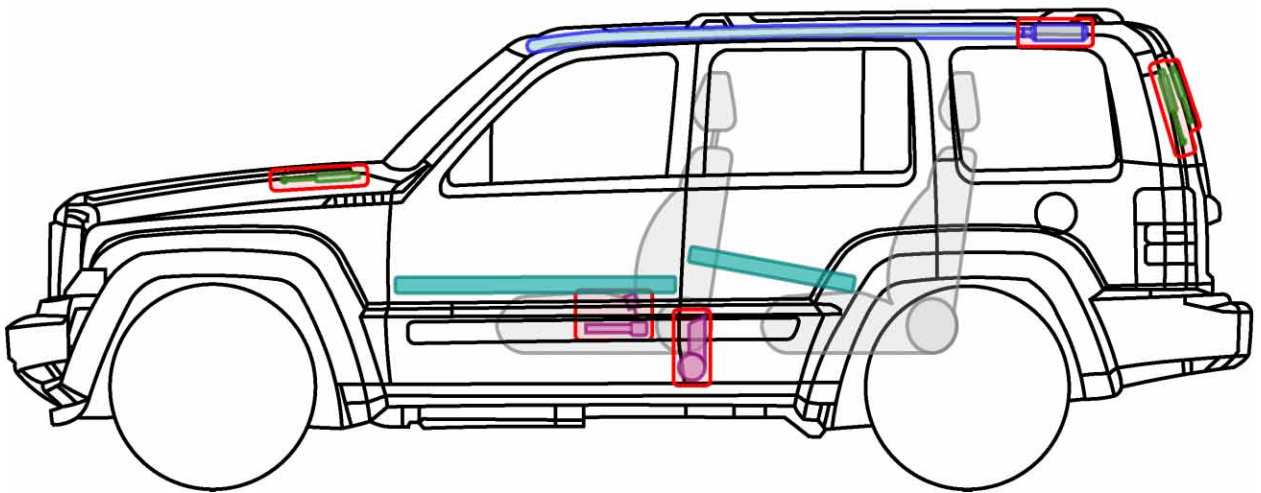
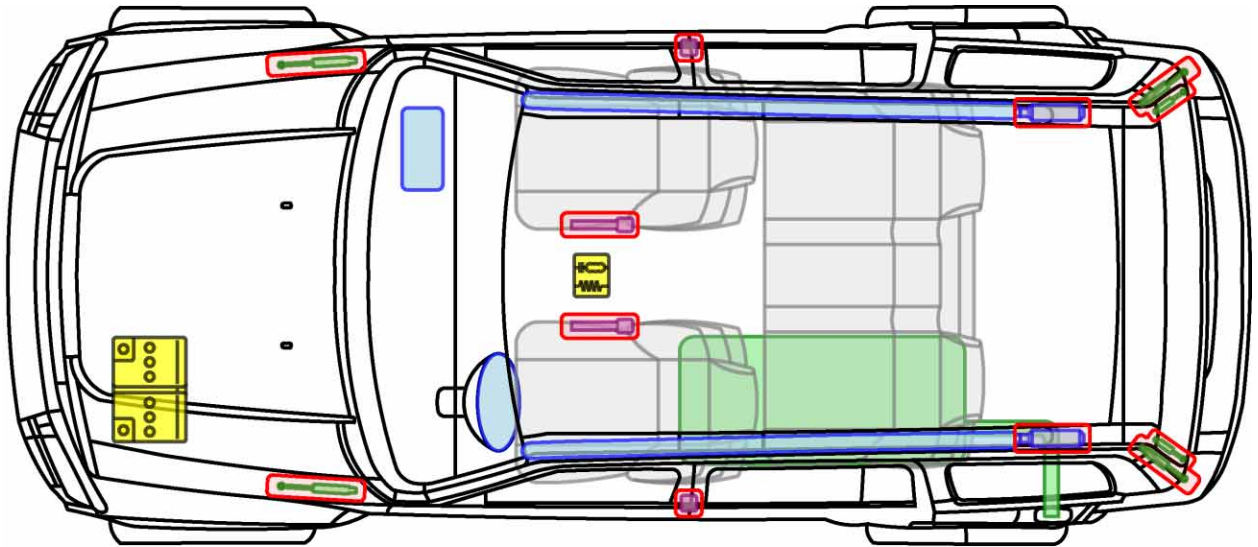

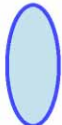

**Legende**

	Airbag		Karosserie- verstärkung		Steuergerät		Gastank
	Gas- generator		Überroll- schutz		Batterie		Sicherheits- ventil
	Gurt- straffer		Gasdruck- dämpfer		Kraftstoff- tank		

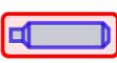

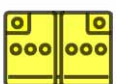

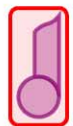



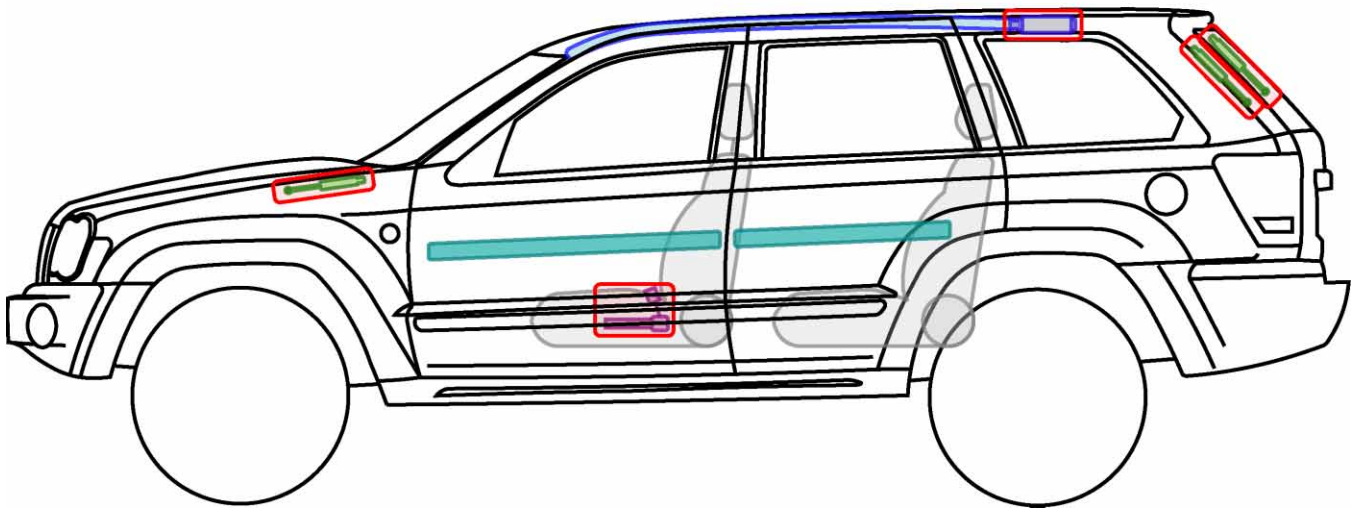
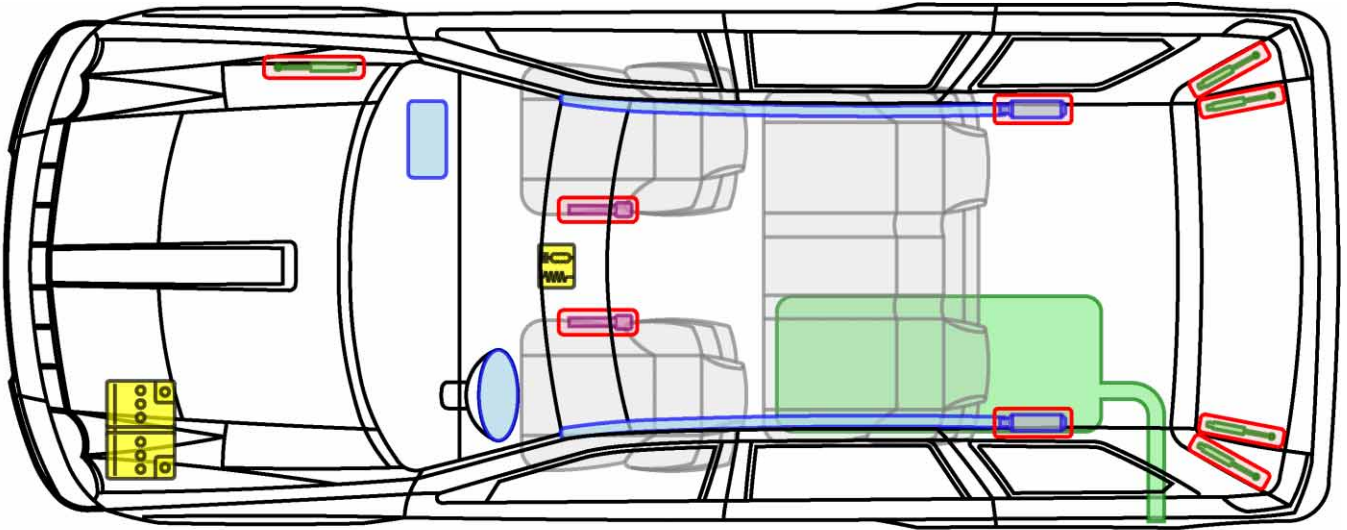



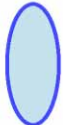

### Legende

	Airbag		Karosserie- verstärkung		Steuergerät		Gastank
	Gas- generator		Überroll- schutz		Batterie		Sicherheits- ventil
	Gurt- straffer		Gasdruck- dämpfer		Kraftstoff- tank		



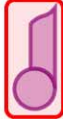



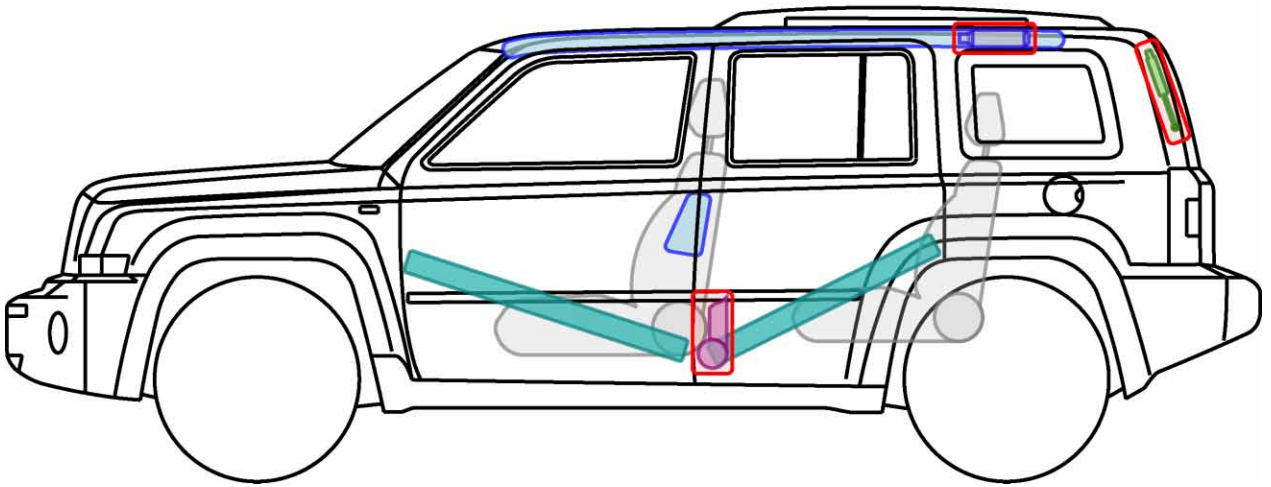
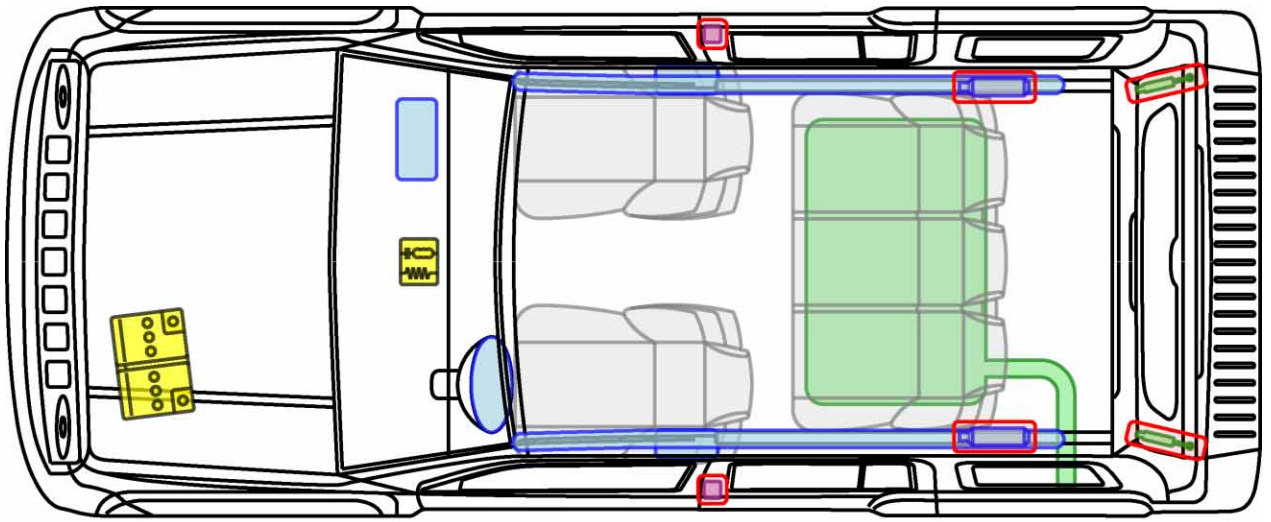



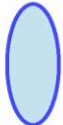

### Legende

	Airbag		Karosserie- verstärkung		Steuergerät		Gastank
	Gas- generator		Überroll- schutz		Batterie		Sicherheits- ventil
	Gurt- straffer		Gasdruck- dämpfer		Kraftstoff- tank		

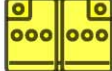

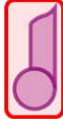



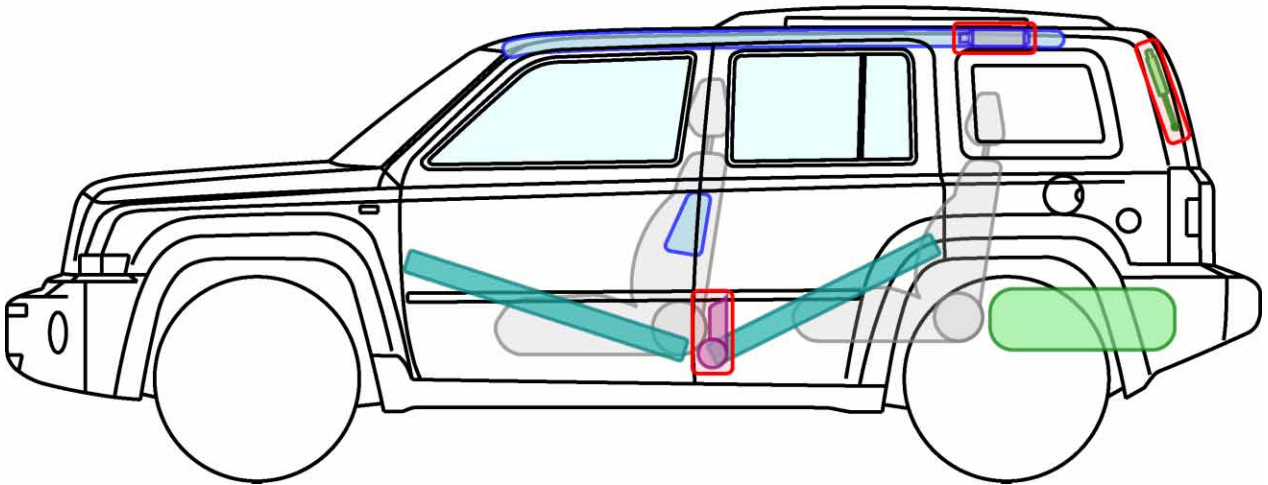
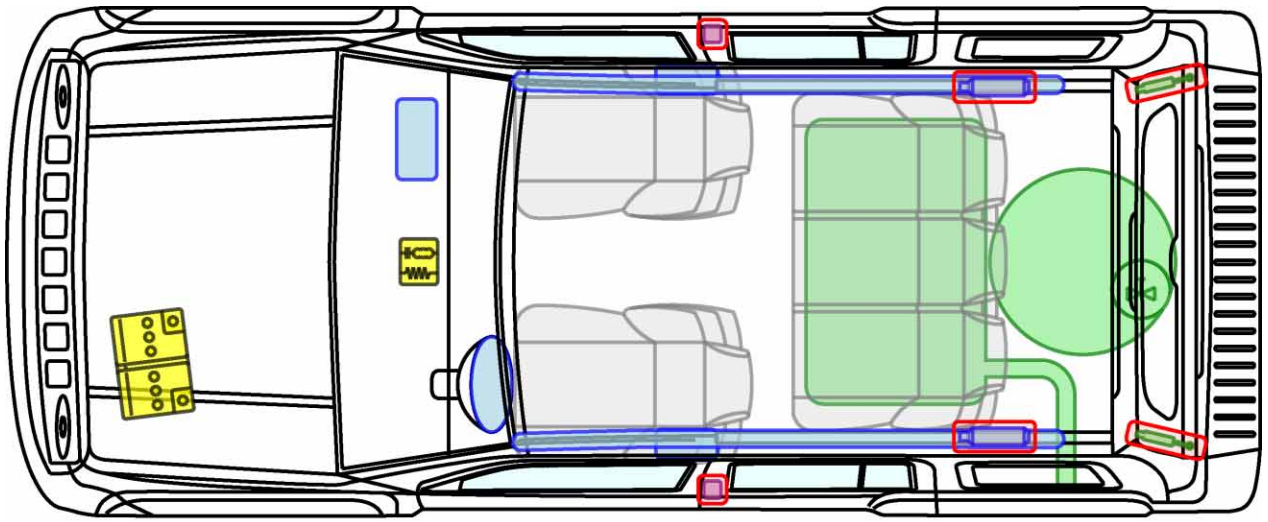



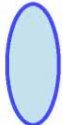

### Legende

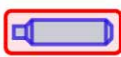
	Airbag		Karosserie- verstärkung		Steuergerät		Gastank
	Gas- generator		Überroll- schutz		Batterie		Sicherheits- ventil
	Gurt- straffer		Gasdruck- dämpfer		Kraftstoff- tank		







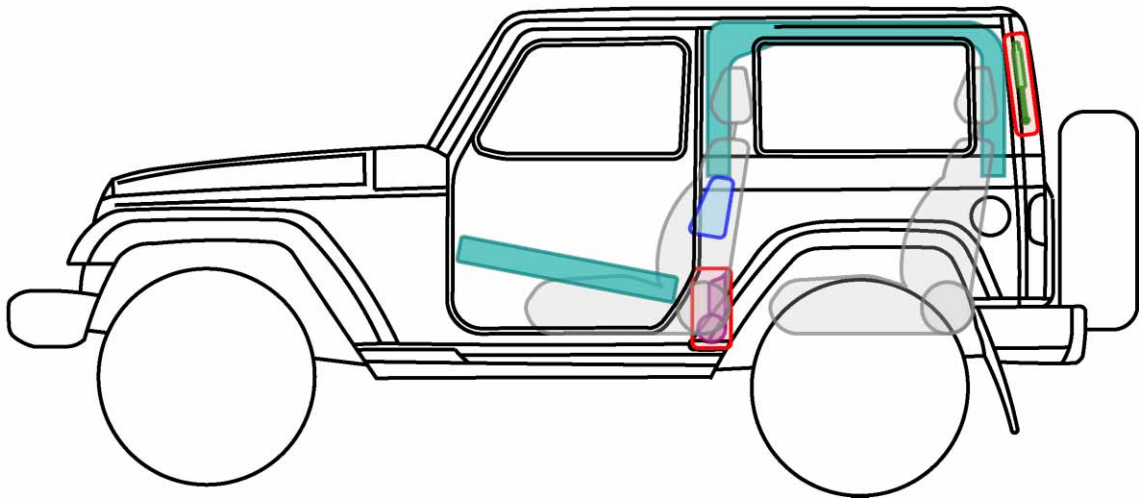
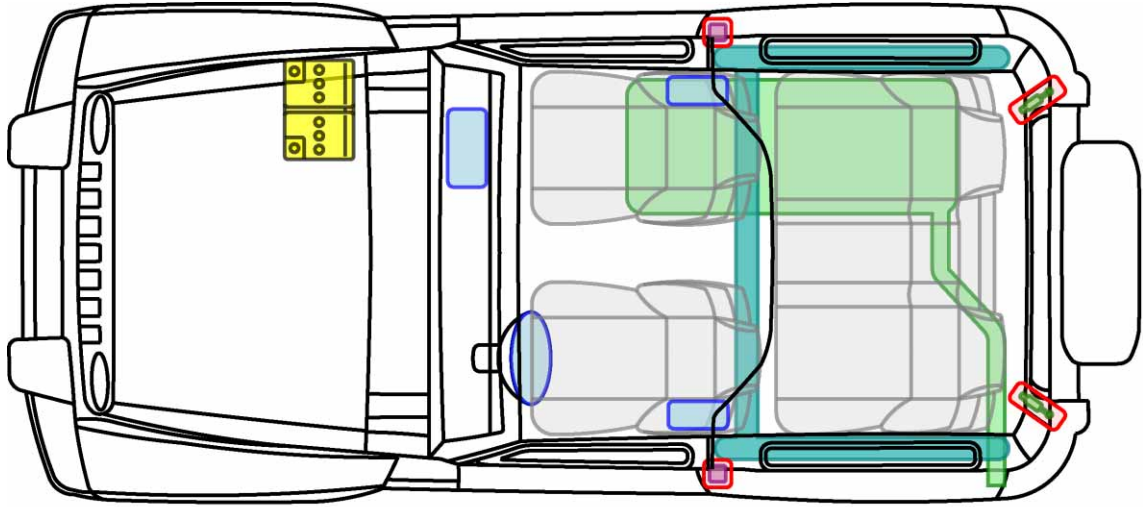



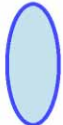

### Legende

	Airbag		Karosserie- verstärkung		Steuergerät		Gastank
	Gas- generator		Überroll- schutz		Batterie		Sicherheits- ventil
	Gurt- straffer		Gasdruck- dämpfer		Kraftstoff- tank		







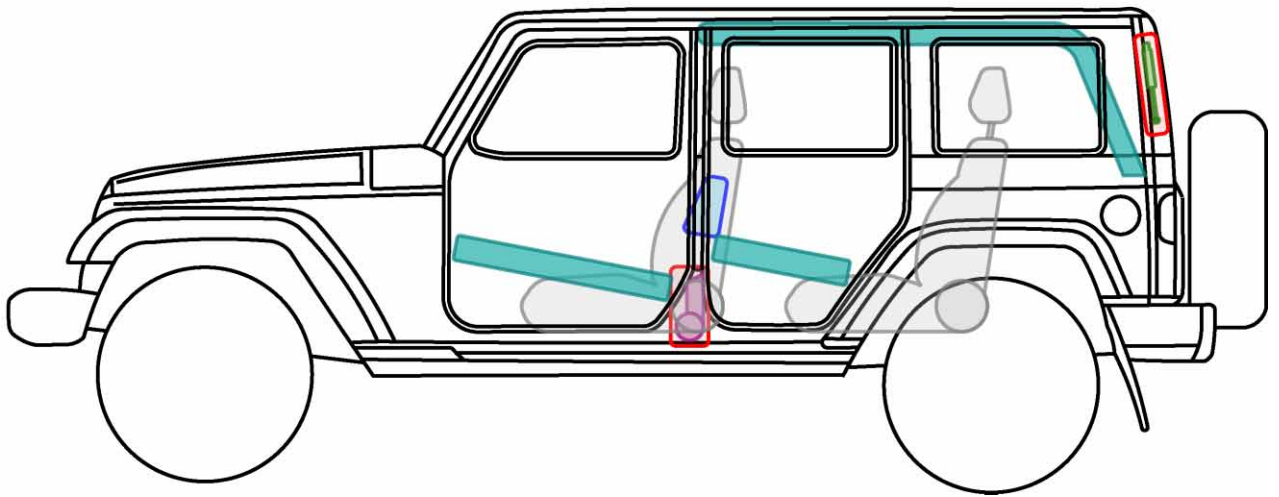
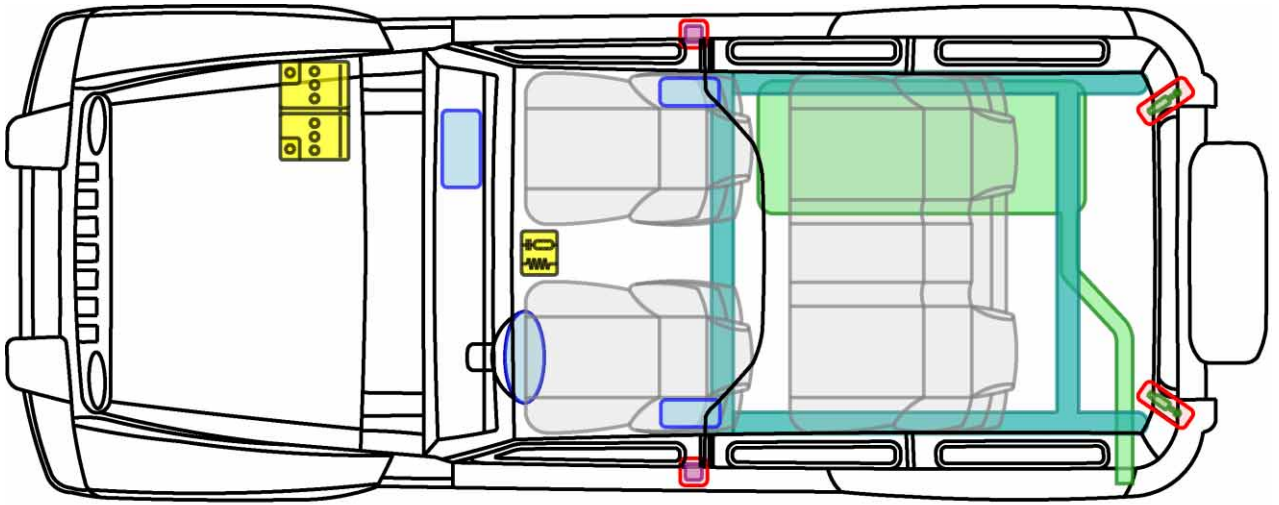



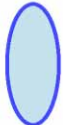

### Legende

	Airbag		Karosserie- verstärkung		Steuergerät		Gastank
	Gas- generator		Überroll- schutz		Batterie		Sicherheits- ventil
	Gurt- straffer		Gasdruck- dämpfer		Kraftstoff- tank		

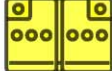

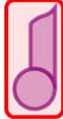
### Legende

	Airbag		Karosserie- verstärkung		Steuergerät		Gastank
	Gas- generator		Überroll- schutz		Batterie		Sicherheits- ventil
	Gurt- straffer		Gasdruck- dämpfer		Kraftstoff- tank		



# Journey

Typ: JC, 2009-

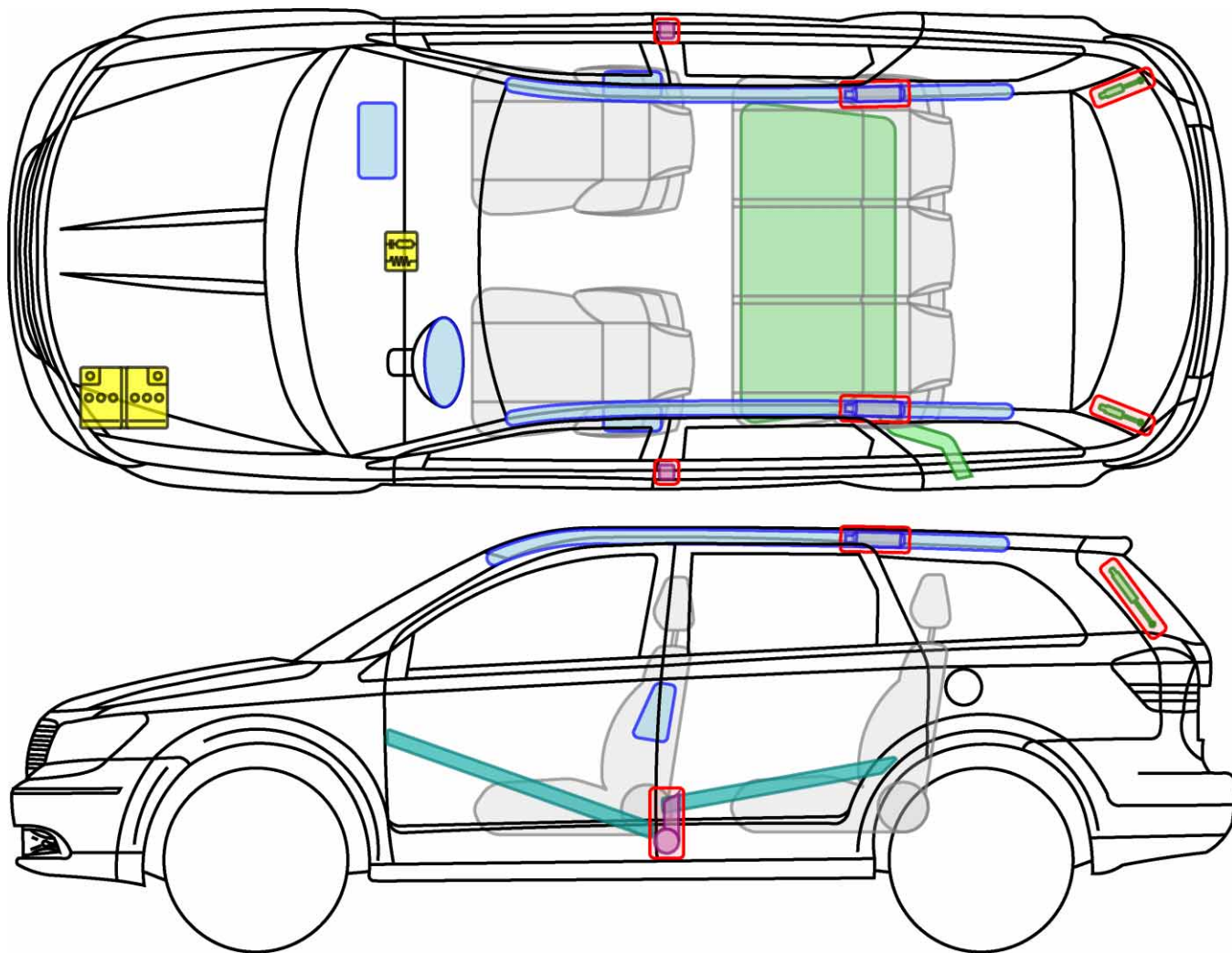

## Legende

	Airbag		Karosserie- verstärkung		Steuergerät		Gastank
	Gas- generator		Überroll- schutz		Batterie		Sicherheits- ventil
	Gurt- straffer		Gasdruck- dämpfer		Kraftstoff- tank		

Dodge







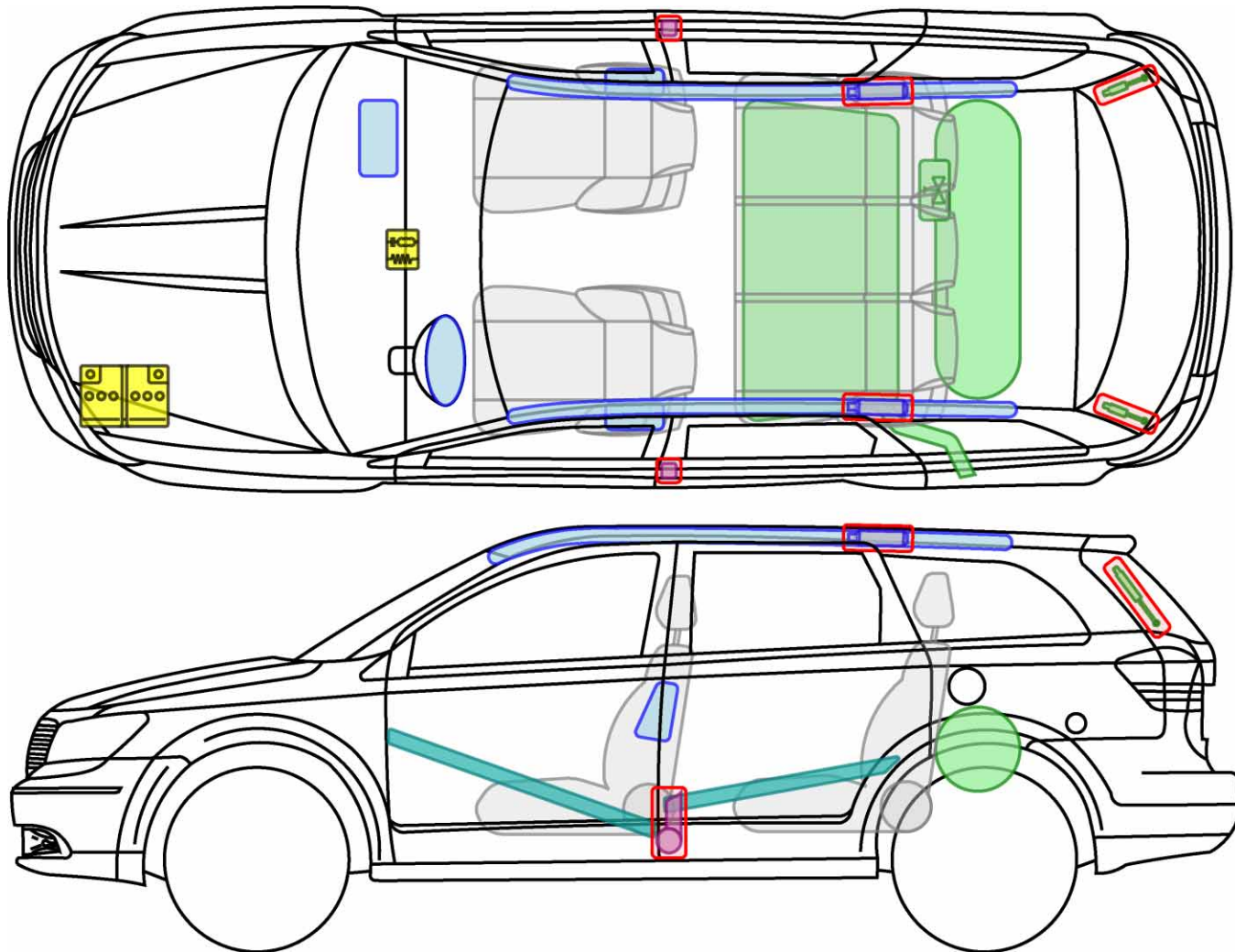



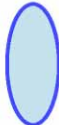

**Journey** **ECO+**  
LPI-FLÜSSIGGAS-TECHNOLOGIE

Typ: JC, 2009-

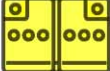

**Legende**

	Airbag		Karosserie- verstärkung		Steuergerät		Gastank
	Gas- generator		Überroll- schutz		Batterie		Sicherheits- ventil
	Gurt- straffer		Gasdruck- dämpfer		Kraftstoff- tank		

**Dodge**





# Caliber

Typ: PK, 2006-

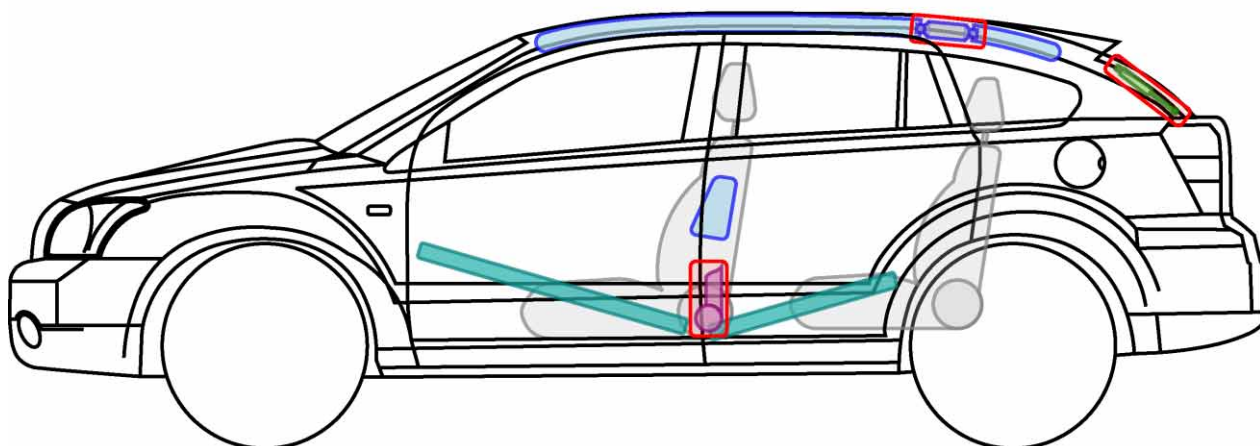
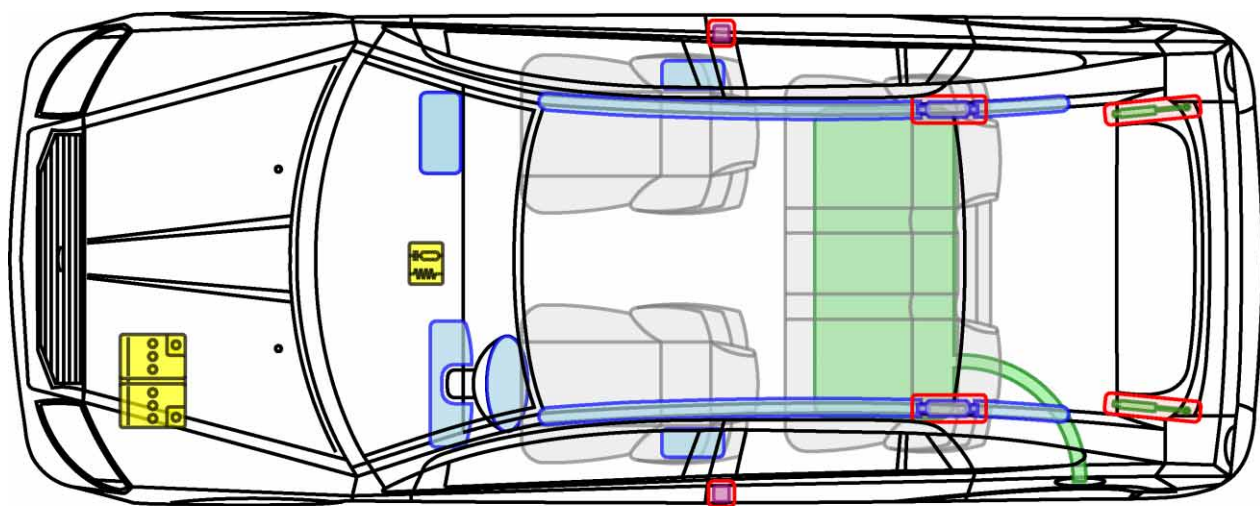

## Legende

	Airbag		Karosserie- verstärkung		Steuergerät		Gastank
	Gas- generator		Überroll- schutz		Batterie		Sicherheits- ventil
	Gurt- straffer		Gasdruck- dämpfer		Kraftstoff- tank		

Dodge



# Nitro

Typ: KJ, 2007-

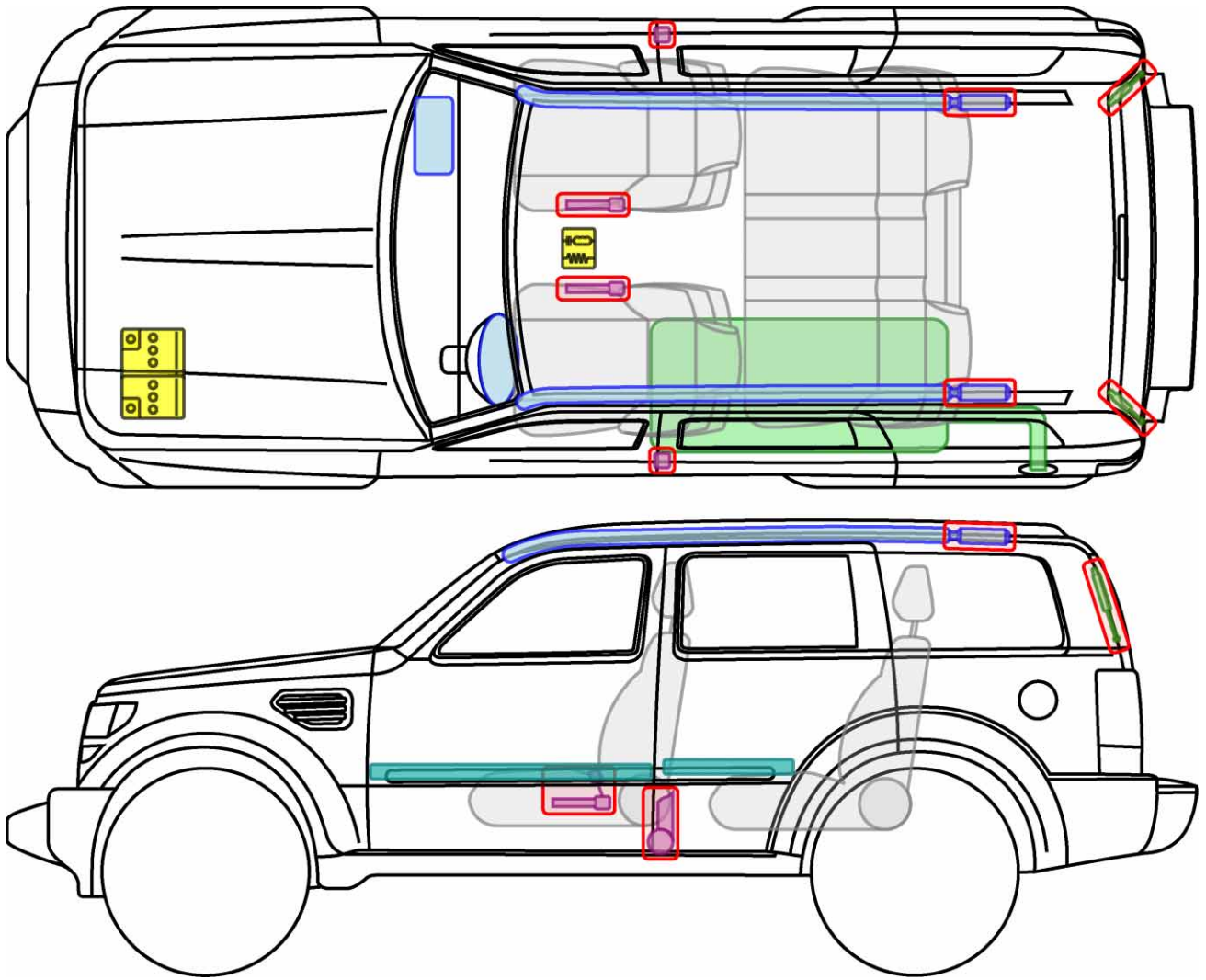

## Legende

	Airbag		Karosserie- verstärkung		Steuergerät		Gastank
	Gas- generator		Überroll- schutz		Batterie		Sicherheits- ventil
	Gurt- straffer		Gasdruck- dämpfer		Kraftstoff- tank		

Dodge